

■ ULTRATORCH® MODEL UT-100 & UT-100SI TIPS















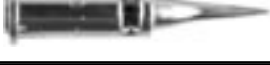















Quick Jump:



For use with UT-100 & UT-100Si Ultratorches

- Ultratorch soldering tips feature Ultratip™ Technology, the long lasting, oxygen-free, copper based, iron and chrome plated tip with a built-in catalyst, pre-tinned with lead-free solder. [Click here](#) for more information on Ultratip™ Technology
- Ultratips are the perfect soldering tips for use with today's lead-free soldering materials
- More than double the iron plating thickness of our competitor's brass based tips, providing higher thermal conductivity and longer tip life
- Multiple hot air tip sizes meet the demand of various applications
- Tip adapter to create your own tips for your unique application

ORDERING INFORMATION

PART NO.	ITEM NO.		DESCRIPTION
ULTRATIP™ SOLDERING TIPS			
70-01-01	35107		1.0mm dia. tapered needle soldering tip (Standard with UT-100SiP)
70-01-02	35050		3.3mm dia. chisel soldering tip (Standard with all models)
70-01-03	35108		2.0mm dia. spade soldering tip
70-01-04	35109		3.0mm dia. spade soldering tip
70-01-05	35110		0.5mm dia. tapered needle soldering tip (Standard with UT-100SiP)
70-01-06	35111		2.0mm dia. micro spade soldering tip
70-01-07	35112		0.5mm dia square tapered pyramid soldering tip
70-01-08	35113		2.0mm dia. 35° spade soldering tip
70-01-09	35114		3.0mm dia. 35° spade soldering tip
70-01-10	35115		1.0mm dia. offset tapered needle soldering tip

70-01-11	35118		8.0mm dia. high powered chisel soldering tip
70-01-12	35119		3.0mm dia. high powered round head needle tip
70-01-13	35120		5.0mm dia. high powered long tapered chisel tip
70-01-15	35122		7.0mm dia 45° spade soldering tip
HOT KNIFE			
70-01-16	35123		Hot knife tip (Standard with UT-100SiP)
HOT AIR TIPS			
70-01-50	35124		2.5 O.D./1.59 I.D. (mm) hot air tip
70-01-51	35125		4.25 O.D./3.3 I.D. (mm) hot air tip
70-01-52	35051		5.7 O.D./4.9 I.D. (mm) hot air tip (Standard with all models)
70-01-53	35126		8.0 O.D./I.D. (mm) hot air tip
ACCESSORIES			
70-01-54	35127		Large heat shrink attachment
70-01-55	35052		Small heat shrink attachment (Standard with all models)
70-02	35128		Protective cap fits UT-100 only
70-35	35046		Ejector spanner wrench (Standard with all models)
70-37U	35047		Tip cleaner sponge (Standard with UT-100, UT-100SiK & UT-100SiP)
70-40U	35048		Metal storage box (Standard with UT-100 & UT-100SiK)
35422	35422		Plastic storage case (Standard with UT-100SiP)
70-43	35049		Tool holder (Standard with UT-100, UT-100SiK & UT-100SiP)
70-52U	35130		Carrying strap

90-02	35053		Protective cap fits UT-100Si only (Standard with UT-100Si & UT-100SiP)
80-40	35056		Open end wrench (Standard with all models)
ADAPTER			
70-01-14	35121		8.4mm tip adapter (4.0mm dia x 0.7mm pitch)

Users should independently evaluate the suitability of the product for their application.

[HOME](#) [BACK TO PRODUCT LISTING](#)